

Bulletin HY14-2105/US

Series MV5 Mini-Pak Directional Control Valves

Effective: February 1, 2004
Supersedes: Cat. No. PMF 1004 dated 10/99

Features

- Superior versatility in many combinations of different working sections
- Unique series/parallel banking
- Full manual overrides
- Optional high flow inlets (low ΔP)
- Solenoid coils are weather-resistant and provide continuous duty at nominal rated voltage
- Proportional flow inlet
- Both open and closed center configurations
- Power beyond feature

Description

The Parker Series MV4 Mini-Pak, solenoid-operated valves provide multiple-function directional control. The modular banking design concept eliminates costly fittings and potential leak points. Parker Mini-Pak valves are easy to install in both the factory and in the field.

Solenoid actuator construction utilizes the proven wet plunger design. Series, parallel and series-parallel valve circuitry offers application flexibility and energy savings potential.

Specifications

Flow: 6 GPM (23 L/M).

Operating Pressure: 3000 PSI (207 Bar) maximum.

Operating Fluid: Standard petroleum-based.

Leakage C-T at 3000 PSI (207 Bar): 10.8 in³/min. (177 cc/min.) at 100°F (38°C), 150 SSU (32 cSt).

Filtration Requirement: Recommend 25 micron (nominal). Class 18/15 according to ISO 4406, or cleaner.

PERFORMANCE

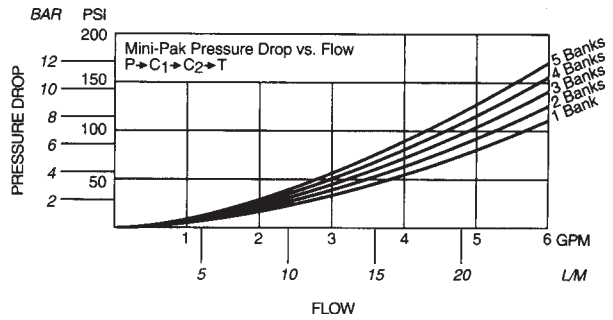
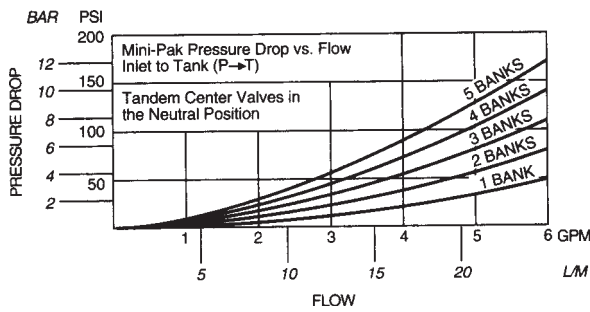

NOTE: SAE 10 oil at 100°F (38°C), Viscosity 150 SSU (32 cSt)

MATERIALS

Construction: Hardened steel spool, precision fit into high-strength alloy cast iron body. Buna "N" seals. Solenoid coils are epoxy-encapsulated (weather-resistant), with Class H magnet wire and PVC-coated lead wires.

Porting: SAE-6 (9/16 -18 thread)

Banking Limitation:

Recommended to 5 sections only. Additional sections on factory-approved applications.

Tie Rod Torque Specification:

115-125 lb. in. (13.0-14.1 N-m)

Shipping Weight Per Section:

9.5 lbs. (4.3 kg) approx.

ELECTRICAL DATA

Input Voltages: 9, 12, 24 VDC or 115 VAC 50/60 Hz.

Current Draw:

9 VDC — 3.1 A at 68° F (20°C)

12 VDC — 2.4 A at 68° F (20°C)

24 VDC — 1.2 A at 68° F (20°C)

115 VAC — .30 A at 68° F (20°C)

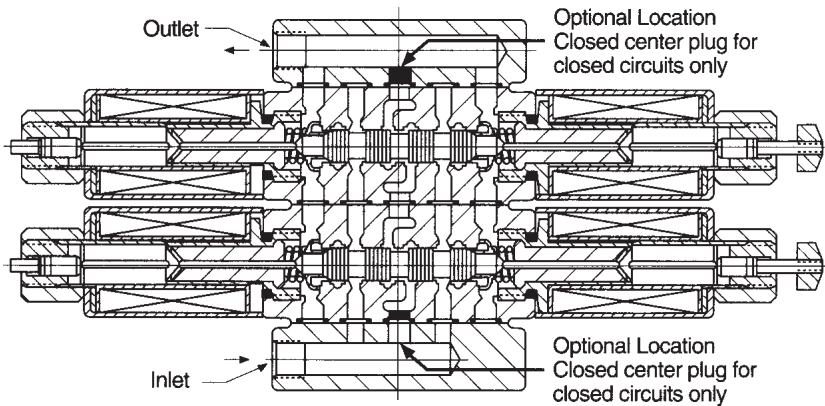

DIMENSIONS

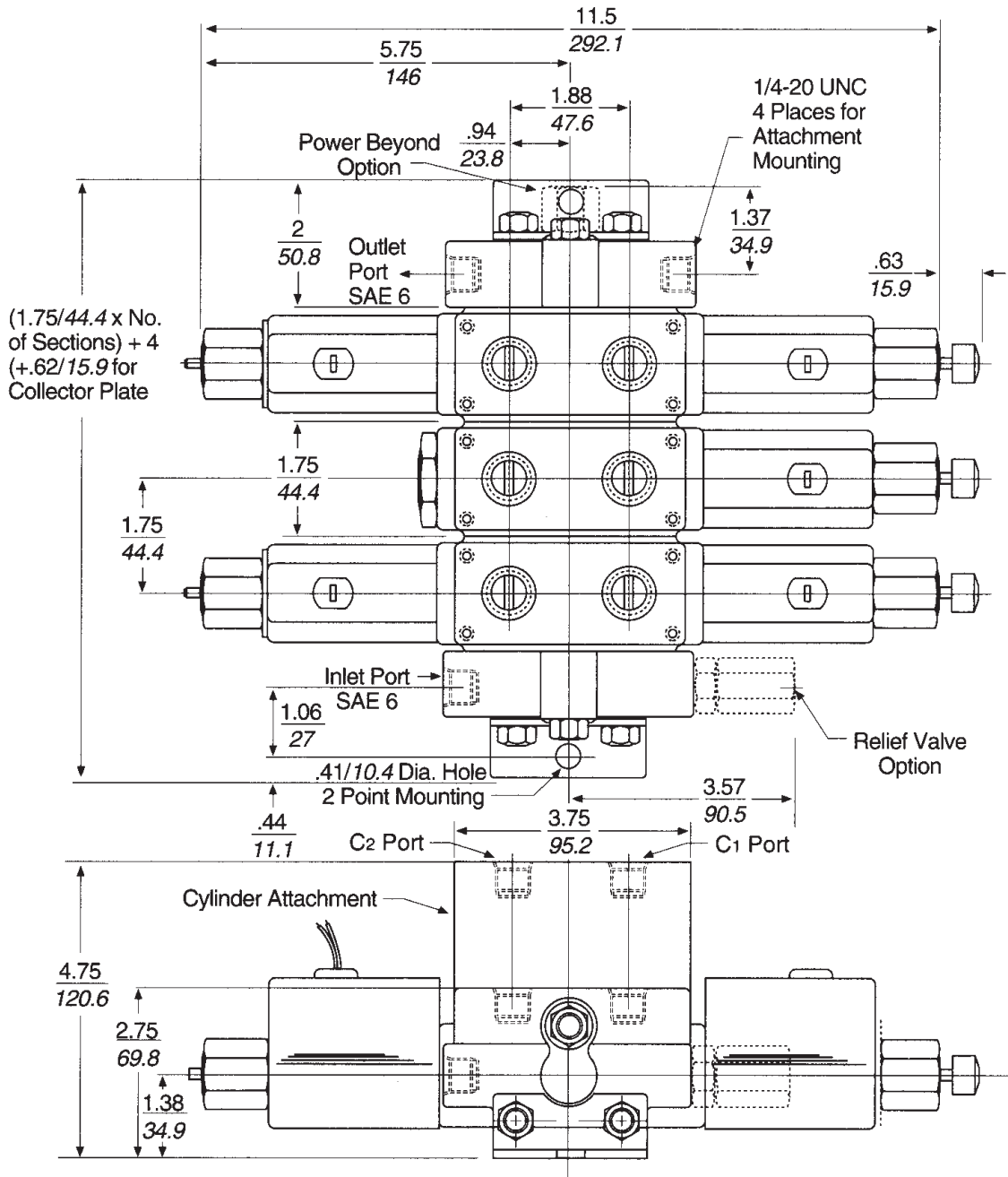

DIMENSIONS ARE IN INCHES (MILLIMETERS) AND ARE FOR REFERENCE ONLY.

OPTIONS

OPTIONS

- Integral adjustable inlet relief valve.
- Priority inlet with direct-acting relief valve.
- Convertible to open center series or closed center parallel circuit stacks.
- Accessory cylinder port attachments.
- Bankable manual sections may be installed upstream of solenoid sections.
- Palm button manual override.
- Proportional flow inlet.
- Variety of coil terminations.

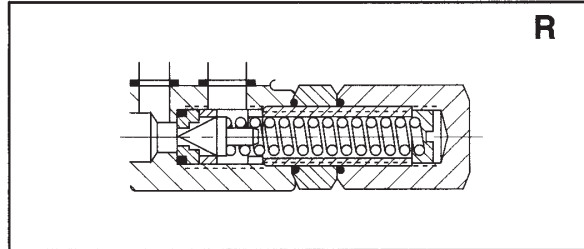

R

Direct Acting Relief Valve

Adjustable in 2 pressure ranges: 50-500/500-3000 psi (3.5-35/35-207 BAR)

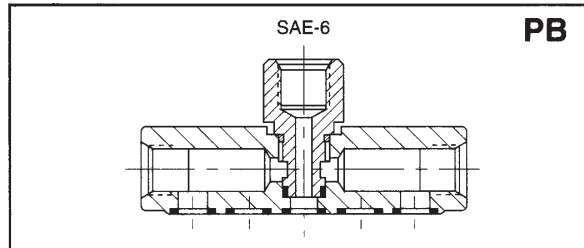

PB

Power Beyond Outlet Section

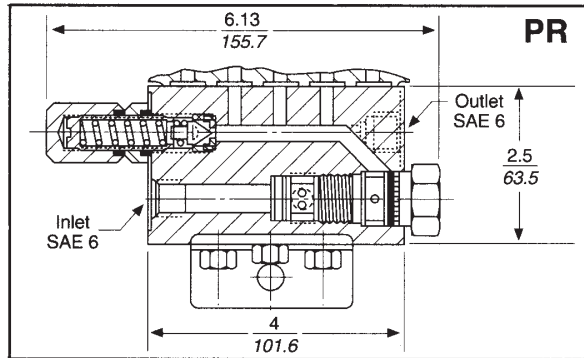

PR

Priority Inlet with Direct Acting Relief

Adjustable in 2 pressure ranges: 50-500/500-3000 psi (3.5-35/35-207 BAR)

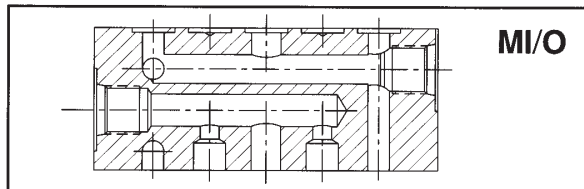

MI/O

Mid Inlet/Outlet

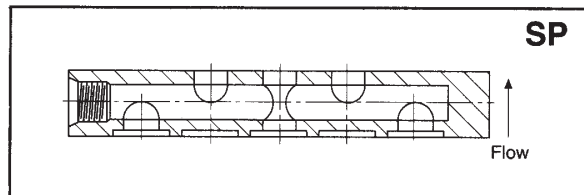

SP

Series Conversion Plate

Used in series circuits

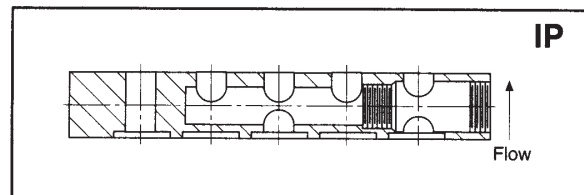

IP

Isolator Plate

Used to isolate downstream sections

ORDER CODE

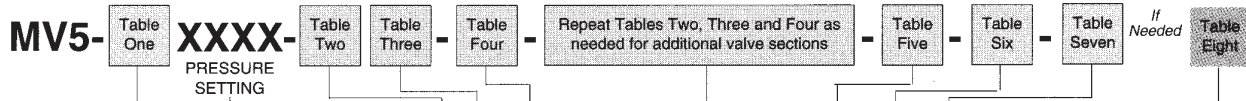

Example: MV5-R2000-10A-SP-10TT-SP-10A-SO-12-LA MV5-BK5
 (Complete Assembly)

Example on ordering individual parts: MV5-SI or MV5-10-12-LA

TABLE ONE	
SI	Standard Inlet
RI	Reverse Ported Inlet
DIP	Dual Ported Inlet Ports
R	Inlet with Direct Acting Adjustable Relief
PR	Inlet With Priority Flow and Direct Acting Relief
EF	Proportional Inlet with Direct Acting Relief (Bypass port T2 must go directly to tank)

Specify pressure setting on **R**
Specify pressure and flow on **PR**

TABLE TWO	
10	3 position 4 way N/C (C1 and C2 Blocked)
14	3 position 4 way Motor (C1 and C2 Open to Tank)
17	3 position 4 way C1 Plugged (Single acting cyl. circuit)
20	2 position 4 way N/C (C1 and C2 Blocked)
25	2 position 4 way N/O (C1 and C2 Open)
35	2 position 4 way Selector (P to C1 C2 to tank) Must be used with IP plate
JJ	Palm button manual override

(Note: Spool number precedes JJ designation)

TABLE THREE	
A	Dual lock valve
B	Lock valve with thermal relief
F	Crossover relief fixed setting (Specify pressure settings)
TT	Crossover reliefs (Adjustable 0-3000 psi)
L	Single lock valve (Specify work port)

Specify pressure setting

TABLE FOUR	
SP	Converts the power-beyond port to a true series circuit
IP	Isolates the valve sections down stream

Omit if not required

TABLE FIVE	
SO	Standard Outlet (Open Circuit)
SC	Standard Outlet (Closed Circuit)
PB-	Power beyond (Open Circuit)
DTO	Dual tank Outlet (Open Circuit)
DTC	Dual tank Outlet (Closed circuit)
NO	Open Outlet w/reverse check (Open Circuit only)

TABLE SIX		
Coil	Part #	
9	CO4-9-LA	9 volts DC
	CO4-9-TD	
12	CO4-12-LA	12 volts DC
	CO4-12-TD	
24	CO4-24-LA	24 volts DC
	CO4-24-TD	
115	CO4-115-LA	115 volts AC

TABLE SEVEN		
LA		9 volts DC 12 volts DC 24 volts DC 115 volts DC
TD		9 volts DC 12 volts DC 24 volts DC

TABLE EIGHT	
MV5-	Banking Kits consist of 3 fatigue proof steel tie rods, 6 hex nuts, 6 washers, mounting brackets. Tie rods are sized to accept an Inlet/Outlet and then the number spool sections and/or conversion plates required.
BK1	1 spool section+inlet/outlet
BK2	2 spool section+inlet/outlet
BK3	3 spool section+inlet/outlet
BK4	4 spool section+inlet/outlet
BK5	5 spool section+inlet/outlet

Please consult factory when stacking more than 5 sections.

ACCESSORIES	
Attachment bolt Kits	
MV5-AK1	Single attachment
MV5-AK2	Double attachment

Please Note: "O" rings are shipped with each valve section.

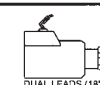
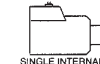
HOW TO ORDER: Parker Mini-Pak Valves are coded by the assembled stack configuration (Left to Right) in a sequential order from inlet to outlet. Please refer to the ordering tables, to select a circuit type, inlet options, spool configuration, spool options, circuit conversion options as they apply to your application.

Offer of Sale

The items described in this document and other documents or descriptions provided by Parker Hannifin Corporation, its subsidiaries and its authorized distributors are hereby offered for sale at prices to be established by Parker Hannifin Corporation, its subsidiaries and its authorized distributors. This offer and its acceptance by any customer ("Buyer") shall be governed by all of the following Terms and Conditions. Buyer's order for any such items, when communicated to Parker Hannifin Corporation, its subsidiary or an authorized distributor ("Seller") verbally or in writing, shall constitute acceptance of this offer.

1. Terms and Conditions of Sale: All descriptions, quotations, proposals, offers, acknowledgments, acceptances and sales of Seller's products are subject to and shall be governed exclusively by the terms and conditions stated herein. Buyer's acceptance of any offer to sell is limited to these terms and conditions. Any terms or conditions in addition to, or inconsistent with those stated herein, proposed by Buyer in any acceptance of an offer by Seller, are hereby objected to. No such additional, different or inconsistent terms and conditions shall become part of the contract between Buyer and Seller unless expressly accepted in writing by Seller. Seller's acceptance of any offer to purchase by Buyer is expressly conditional upon Buyer's assent to all the terms and conditions stated herein, including any terms in addition to, or inconsistent with those contained in Buyer's offer. Acceptance of Seller's products shall in all events constitute such assent.

2. Payment: Payment shall be made by Buyer net 30 days from the date of delivery of the items purchased hereunder. Amounts not timely paid shall bear interest at the maximum rate permitted by law for each month or portion thereof that the Buyer is late in making payment. Any claims by Buyer for omissions or shortages in a shipment shall be waived unless Seller receives notice thereof within 30 days after Buyer's receipt of the shipment.

3. Delivery: Unless otherwise provided on the face hereof, delivery shall be made F.O.B. Seller's plant. Regardless of the method of delivery, however, risk of loss shall pass to Buyer upon Seller's delivery to a carrier. Any delivery dates shown are approximate only and Seller shall have no liability for any delays in delivery.

4. Warranty: Seller warrants that the items sold hereunder shall be free from defects in material or workmanship for a period of 18 months from date of shipment from Parker Hannifin Corporation. **THIS WARRANTY COMPRISES THE SOLE AND ENTIRE WARRANTY PERTAINING TO ITEMS PROVIDED HEREUNDER. SELLER MAKES NO OTHER WARRANTY, GUARANTEE, OR REPRESENTATION OF ANY KIND WHATSOEVER. ALL OTHER WARRANTIES, INCLUDING BUT NOT LIMITED TO, MERCHANTABILITY AND FITNESS FOR PURPOSE, WHETHER EXPRESS, IMPLIED, OR ARISING BY OPERATION OF LAW, TRADE USAGE, OR COURSE OF DEALING ARE HEREBY DISCLAIMED. NOTWITHSTANDING THE FOREGOING, THERE ARE NO WARRANTIES WHATSOEVER ON ITEMS BUILT OR ACQUIRED WHOLLY OR PARTIALLY, TO BUYER'S DESIGNS OR SPECIFICATIONS.**

5. Limitation Of Remedy: SELLER'S LIABILITY ARISING FROM OR IN ANY WAY CONNECTED WITH THE ITEMS SOLD OR THIS CONTRACT SHALL BE LIMITED EXCLUSIVELY TO REPAIR OR REPLACEMENT OF THE ITEMS SOLD OR REFUND OF THE PURCHASE PRICE PAID BY BUYER, AT SELLER'S SOLE OPTION. IN NO EVENT SHALL SELLER BE LIABLE FOR ANY INCIDENTAL, CONSEQUENTIAL OR SPECIAL DAMAGES OF ANY KIND OR NATURE WHATSOEVER, INCLUDING BUT NOT LIMITED TO LOST PROFITS ARISING FROM OR IN ANY WAY CONNECTED WITH THIS AGREEMENT OR ITEMS SOLD HEREUNDER, WHETHER ALLEGED TO ARISE FROM BREACH OF CONTRACT, EXPRESS OR IMPLIED WARRANTY, OR IN TORT, INCLUDING WITHOUT LIMITATION, NEGLIGENCE, FAILURE TO WARN OR STRICT LIABILITY.

6. Changes, Reschedules and Cancellations: Buyer may request to modify the designs or specifications for the items sold hereunder as well as the quantities and delivery dates thereof, or may request to cancel all or part of this order, however, no such requested modification or cancellation shall become part of the contract between Buyer and Seller unless accepted by Seller in a written amendment to this Agreement. Acceptance of any such requested modification or cancellation shall be at Seller's discretion, and shall be upon such terms and conditions as Seller may require.

7. Special Tooling: A tooling charge may be imposed for any special tooling, including without limitation, dies, fixtures, molds and patterns, acquired to manufacture items sold pursuant to this contract. Such special tooling shall be and remain Seller's property notwithstanding payment of any charges by Buyer. In no event will Buyer acquire any interest in apparatus belonging to Seller which is utilized in the manufacture of the items sold hereunder, even if such apparatus has been specially converted or adapted for such manufacture and notwithstanding any charges paid

by Buyer. Unless otherwise agreed, Seller shall have the right to alter, discard or otherwise dispose of any special tooling or other property in its sole discretion at any time.

8. Buyer's Property: Any designs, tools, patterns, materials, drawings, confidential information or equipment furnished by Buyer or any other items which become Buyer's property, may be considered obsolete and may be destroyed by Seller after two (2) consecutive years have elapsed without Buyer placing an order for the items which are manufactured using such property, Seller shall not be responsible for any loss or damage to such property while it is in Seller's possession or control.

9. Taxes: Unless otherwise indicated on the face hereof, all prices and charges are exclusive of excise, sales, use, property, occupational or like taxes which may be imposed by any taxing authority upon the manufacture, sale or delivery of the items sold hereunder. If any such taxes must be paid by Seller or if Seller is liable for the collection of such tax, the amount thereof shall be in addition to the amounts for the items sold. Buyer agrees to pay all such taxes or to reimburse Seller therefore upon receipt of its invoice. If Buyer claims exemption from any sales, use or other tax imposed by any taxing authority, Buyer shall save Seller harmless from and against any such tax, together with any interest or penalties thereon which may be assessed if the items are held to be taxable.

10. Indemnity For Infringement of Intellectual Property Rights: Seller shall have no liability for infringement of any patents, trademarks, copyrights, trade dress, trade secrets or similar rights except as provided in this Part 10. Seller will defend and indemnify Buyer against allegations of infringement of U.S. Patents, U.S. Trademarks, copyrights, trade dress and trade secrets (hereinafter 'Intellectual Property Rights'). Seller will defend at its expense and will pay the cost of any settlement or damages awarded in an action brought against Buyer based on an allegation that an item sold pursuant to this contract infringes the Intellectual Property Rights of a third party. Seller's obligation to defend and indemnify Buyer is contingent on Buyer notifying Seller within ten (10) days after Buyer becomes aware of such allegations of infringement, and Seller having sole control over the defense of any allegations or actions including all negotiations for settlement or compromise. If an item sold hereunder is subject to a claim that it infringes the Intellectual Property Rights of a third party, Seller may, at its sole expense and option, procure for Buyer the right to continue using said item, replace or modify said item so as to make it noninfringing, or offer to accept return of said item and return the purchase price less a reasonable allowance for depreciation. Notwithstanding the foregoing, Seller shall have no liability for claims of infringement based on information provided by Buyer, or directed to items delivered hereunder for which the designs are specified in whole or part by Buyer, or infringements resulting from the modification, combination or use in a system of any item sold hereunder. The foregoing provisions of this Part 10 shall constitute Seller's sole and exclusive liability and Buyer's sole and exclusive remedy for infringement of Intellectual Property Rights. If a claim is based on information provided by Buyer or if the design for an item delivered hereunder is specified in whole or in part by Buyer, Buyer shall defend and indemnify Seller for all costs, expenses or judgments resulting from any claim that such item infringes any patent, trademark, copyright, trade dress, trade secret or any similar right.

11. Force Majeure: Seller does not assume the risk of and shall not be liable for delay or failure to perform any of Seller's obligations by reason of circumstances beyond the reasonable control of Seller (hereinafter 'Events of Force Majeure'). Events of Force Majeure shall include without limitation, accidents, acts of God, strikes or labor disputes, acts, laws, rules or regulations of any government or government agency, fires, floods, delays or failures in delivery of carriers or suppliers, shortages of materials and any other cause beyond Seller's control.

12. Entire Agreement/Governing Law: The terms and conditions set forth herein, together with any amendments, modifications and any different terms or conditions expressly accepted by Seller in writing, shall constitute the entire Agreement concerning the items sold, and there are no oral or other representations or agreements which pertain thereto. This Agreement shall be governed in all respects by the law of the State of Ohio. No actions arising out of the sale of the items sold hereunder or this Agreement may be brought by either party more than two (2) years after the cause of action accrues.

9/91-P

 **WARNING**

FAILURE OR IMPROPER SELECTION OR IMPROPER USE OF THE PRODUCTS AND/OR SYSTEMS DESCRIBED HEREIN OR RELATED ITEMS CAN CAUSE DEATH, PERSONAL INJURY AND PROPERTY DAMAGE.

This document and other information from Parker Hannifin Corporation, its subsidiaries and authorized distributors provide product and/or system options for further investigation by users having technical expertise. It is important that you analyze all aspects of your application and review the information concerning the product or system in the current product catalog. Due to the variety of operating conditions and applications for these products or systems, the user, through its own analysis and testing, is solely responsible for making the final selection of the products and systems and assuring that all performance, safety and warning requirements of the application are met.

The products described herein, including without limitation, product features, specifications, designs, availability and pricing, are subject to change by Parker Hannifin Corporation and its subsidiaries at any time without notice.

Offer of Sale

The items described in this document are hereby offered for sale by Parker Hannifin Corporation, its subsidiaries or its authorized distributors. This offer and its acceptance are governed by the provisions stated in the "Offer of Sale".

© Copyright 2004, Parker Hannifin Corporation, All Rights Reserved



Parker Hannifin Corporation
Hydraulic Valve Division
520 Ternes Avenue
Elyria, Ohio, USA 44035
Tel: (440) 366-5200
Fax: (440) 366-5253
www.parker.com/hydraulicvalve

Bulletin HY14-2105/US,
3C, 2/04, PHD