



LTM Series

Designed for ease of servicing.
Access to tank interior is not necessary

Specifications:

- Steel zinc plate bushing 3, 5, 10, 11, 12 GPM
- Cast iron bushings 15 thru 100 GPM
- LTM-200 cast aluminum bushing
- Perforated steel support tubes
- 100 mesh stainless steel pleated screen (standard)

Options:

- No bypass or 3 & 5 PSI bypass
- Custom screens available on request
- Stainless nuts 100 pc. minimum



LTM-3, 5, 10,
11 and 12



LTM-15
thru 200

Optional Relief
Valve Shown

Dimensional Details

Model Number	Flow	A NPT	B NPT		C	D	E	A/F HEX DIA.	AREA IN ² (CM) ²
LTM-3	3 GPM 12 LPM	3/4"	3/8"	in mm	4.00 101.6	0.98 25	0.79 20	1.18 30	30 (194)
LTM-5	5 GPM 20 LPM	1"	1/2"	in mm	5.39 137	1.13 28	1.10 28	1.50 38	55 (355)
LTM-10	10 GPM 40 LPM	1-1/4"	3/4"	in mm	7.48 190	1.22 31	1.42 36	1.81 46	90 (581)
LTM-11	15 GPM 60 LPM	1-1/4"	3/4"	in mm	5.75 146	1.30 33	1.65 42	1.97 50	75 (484)
LTM-12	12 GPM 45 LPM	1-1/2"	3/4"	in mm	4.00 101.5	1.30 33	1.66 42	1.97 50	48 (311)
LTM-15	18 GPM 72 LPM	1-1/2"	1"	in mm	8.27 210	1.30 33	1.65 42	1.97 50	110 (710)
LTM-25	25 GPM 100 LPM	2"	1 1/4"	in mm	10.00 254	1.30 33	2.13 54	2.60 66	175 (1129)
LTM-30	30 GPM 120 LPM	3"	1 1/4"	in mm	10.24 260	1.69 43	3.07 78	2.60 66	265 (1709)
LTM-40	30 GPM 120 LPM	3"	1 1/2"	in mm	10.24 260	1.69 43	3.07 78	2.60 66	265 (1709)
LTM-50	40 GPM 160 LPM	3"	2"	in mm	10.24 260	1.69 43	3.07 78	3.23 82	265 (1709)
LTM-60	60 GPM 100 LPM	3"	2 1/2"	in mm	10.24 260	2.01 51	3.07 78	3.54 90	265 (1709)
LTM-75	75 GPM 300 LPM	4"	2 1/2"	in mm	9.69 246	1.81 46	3.78 96	4.65 118	300 (1935)
LTM-100	100 GPM 380 LPM	4"	3"	in mm	11.30 287	1.81 46	3.78 96	4.65 118	355 (2290)
LTM-200	200 GPM 750 LPM	6"	4"	in mm	12.44 316	2.28 58	5.71 145	5.7 144	860 (5547)

See Page 49a for WFN Series Weld Flanges

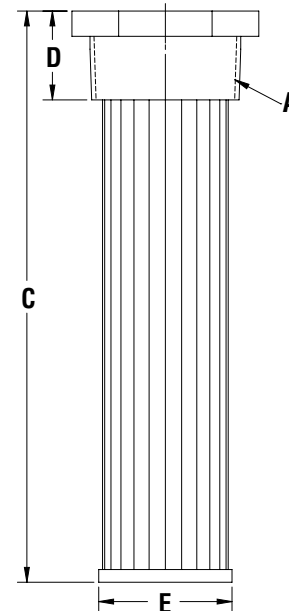
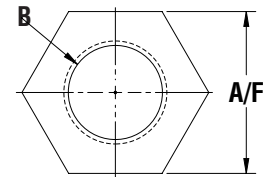

Mounting Details:

Mount through sidewall or through tank top and into standpipe. See page 52a for details.

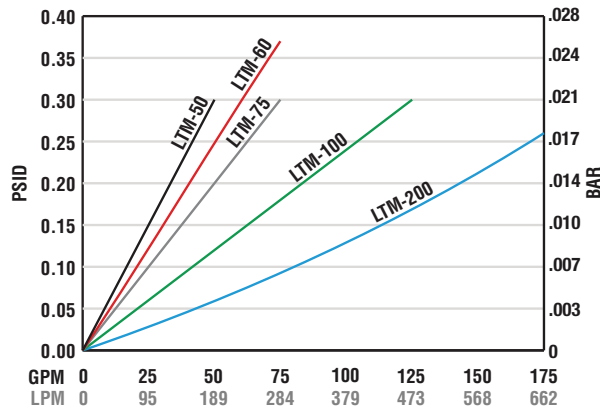
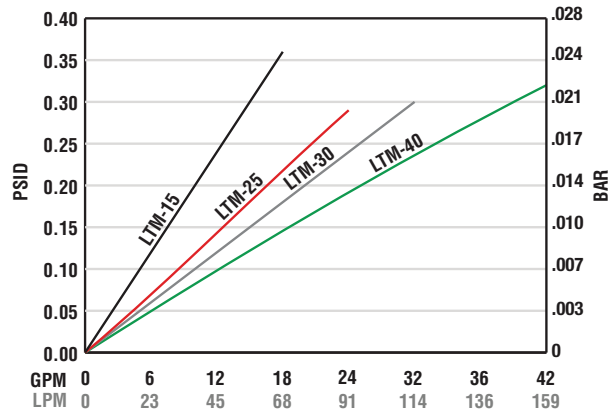
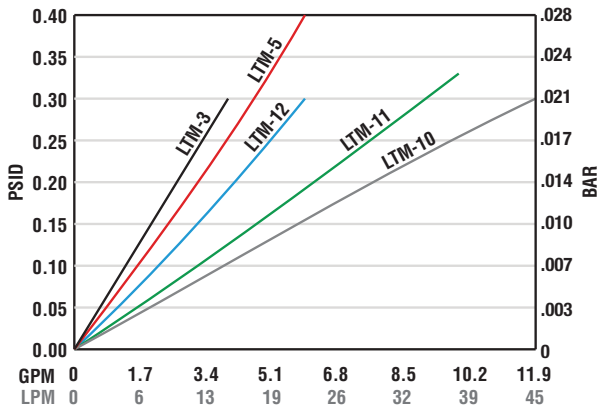

Temperature 100°F Viscosity 150 SUS
Average pressure drop through clean assembly

Strainer Ordering Code

LTM - 15 - R3 - 100 -

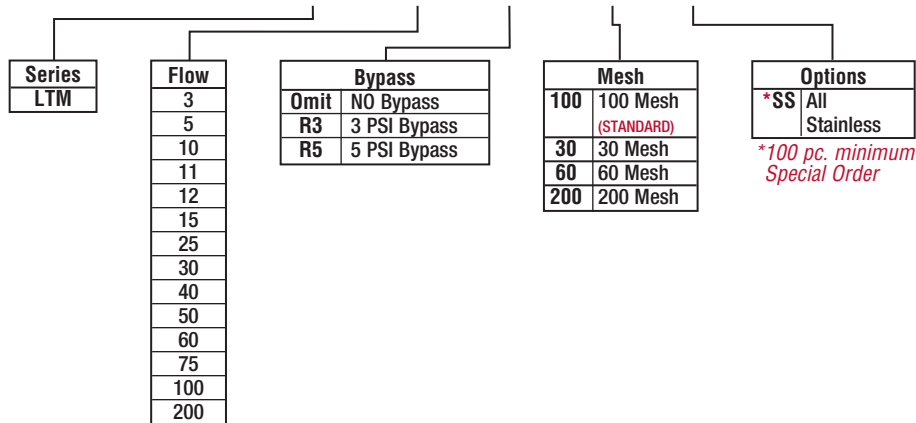

See Technical Bulletin TB.FIL17.708, TB.FIL19.708, or further information at (Technical Data – www.lenzinc.com)



FILTERS – ACTUAL SIZE MESH

LENZ Cleanable Wire Cloth Filters are equipped with Stainless Steel Wire Cloth Elements. The filtering insert elements are available from a coarse 30 mesh up to a fine 200 mesh. To better illustrate mesh sizes, we have shown below the actual size mesh of the 100, 80, 60, 50, 40, and 30 mesh stainless steel wire screen. **The most common are 200, 100, 60, and 30 Stainless Steel Wire Mesh Screen. (100 Mesh LENZ Standard)**

200 Mesh

Wire diameter .0021
Width of opening .0029
Microns = 74
33.6% of open area

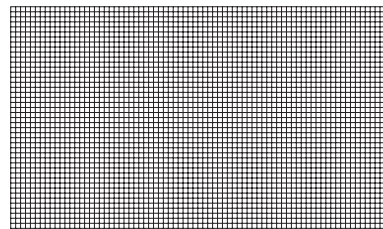
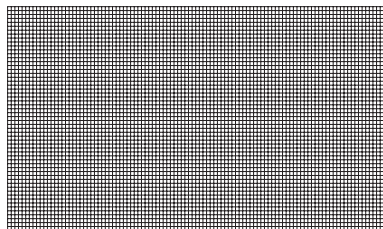

150 Mesh

Wire diameter .0026
Width of opening .0041
Microns = 105

50 Mesh

Wire diameter .0080
Width of opening .0120 = 308 Microns

40 Mesh

Wire diameter .0100
Width of opening .0150 = 385 Microns
36% of open area

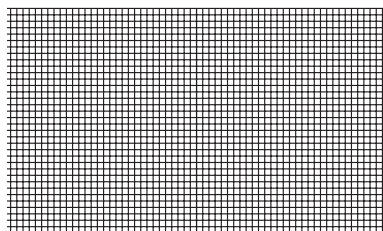
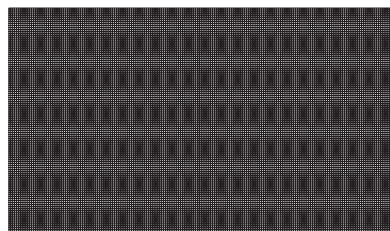

100 Mesh

Wire diameter .0045
Width of opening .0055 = 141 Microns
30.3% of open area

30 Mesh

Wire diameter .0120
Width of opening .0213 = 546 Microns
44.8% of open area

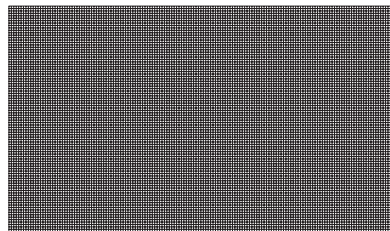

80 Mesh

Wire diameter .0055
Width of opening .0070 = 180 Microns

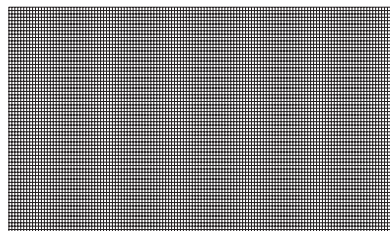

60 Mesh

Wire diameter .0065
Width of opening .0102 = 262 Microns
37.5% of open area

$$\beta_x = \frac{\text{Number of Particles greater than X microns upstream}}{\text{Number of particles greater than X Microns downstream}}$$

$$\beta_5 = 10/1 = 10$$

